

ATEX

Fans for installation in
potentially explosive
areas



VENTILATION
AIR CONDITIONING
AIR CLEANING
HEATING



VORTICE

Air is life

We work to promote quality of life and to contribute to social evolution through eco-friendly products that move air safely and efficiently.



Our current Vortice Headquarters have been located in Tribiano (Milan) since 1972.



Founded in 1974
Vortice France is located at Créteil about 10 Km from Paris.



Founded in 1977
Vortice Limited is located at Burton on Trent in the East Midlands.

Founded in 2010
Our Moscow representative office was established.

Founded in 2012
Vortice Ventilation System is located about 200 Km from Shanghai.

Founded in 2012
Vortice Latam in San José Costa Rica.

Table of Contents

ATEX C-SERIES
PAGE 16



Centrifugal fans for
installation in potentially
explosive areas

ATEX E-SERIES
PAGE 22



Axial plate-mounted fans
for installation in potentially
explosive areas

■ Introduction

The name ATEX comes from the 2 French words 'ATmosphere EXplosible' and is applied to European Directive 94/9/EC dated 23rd March 1994, aimed at the free circulation of products designed for use in potentially explosive areas throughout the European Union.

In Italy, the Directive has been enforced through Presidential Decree 23.03.1998, no. 126 (Official Gazzette, 4th May 1998, no. 101).

This Directive regulates legislation from the various States in terms of electrical and mechanical products intended for use in an area which could become explosive due to the presence of flammable substances in gas, vapour, mist or dust form. For example:

- underground mines,
- petrochemical plants,
- energy production plants (power stations),
- premises used for the production and storage of foodstuffs (flour, cereals, etc.),
- carpentry workshops,
- painting workshops or cabins,
- farms or greenhouses.

ATEX Directive 94/9/EC became a compulsory obligation on 1st July 2003: it is one of the directives illustrating the new approach to matters regarding CE labelling and replaces previous directives 76/117/EEC, 79/196/EEC and 82/130/EEC.

Remember that:

- **Areas at risk of explosion** are those in which an explosive atmosphere may form at levels requiring safety precautions in order to ensure the safety of workers.
- Areas not at risk of explosion are those in which an explosive atmosphere may form at levels which do not require special safety precautions.
- **Flammable and/or combustible substances** are considered substances which may form an explosive atmosphere, unless an examination of their characteristics has NOT demonstrated that they could cause an explosion when mixed with air.

Explosive atmospheres are classified as follows, according to the substance which could trigger the explosion:

G = gas

D = dust

GD = gas and dust.

in potentially explosive areas

■ ATEX Directive 94/9/EC

More commonly known as the ATEX Directive, it applies not only to electrical components, but to all protective equipment and systems intended for use in potentially explosive areas. It also covers all safety, checking and regulatory devices installed just outside the potentially explosive area, where the safety of products installed in areas potentially at risk depends on their efficient operation.

The ATEX Directive lists the product characteristics required for installation in areas at risk of explosion, introducing a classification based on the likelihood of an explosive atmosphere forming.

The new aspect of the ATEX Directive lies in its application to all explosion hazards, even those not considered in previous EC legislation, such as: mechanical components, combustible dust, etc.

In short, ATEX Directive 94/9/EC:

- defines safety requirements for all types of electrical and non-electrical equipment intended for use in the above mentioned environments.

The safety requirements set out by the ATEX Directive must be observed by the manufacturer and/or its agents, and are usually identified by the relevant labelling:



- establishes equipment classification criteria based on the guaranteed protection class in the various application zones: it is the employer's responsibility to classify hazardous areas and identify the required protection class for the products installed, based on the regulations set out by European Directive 1999/92/EC (referring to safety in the workplace), which is actually linked to the ATEX Directive.
- applies to all equipment (including fans) installed in a classified zone. It is the manufacturer's responsibility to ensure that these products conform to the Directive, which also imposes a series of obligations for those selling the product. The company selling the product must keep the CE conformity declaration at the disposal of the relevant authorities for a period of 10 years from the last noted construction date of that product; anyone

who significantly modifies the product becomes the 'manufacturer' and is therefore ultimately and exclusively responsible for ensuring the product conforms to the applicable Directive.

- identifies the officially notified European bodies authorised to examine and verify documentation, and to issue type certificates for the equipment which must be used in zones at risk of explosion.

The following are excluded from the Directive 94/9/EC field of application:

- medical equipment;
- personal protection devices, which are governed by Directive 89/686/EEC, unless otherwise stated;
- protective equipment and systems used in environments where explosive materials or unstable chemical materials are present;
- equipment intended for use in environments where a potentially explosive atmosphere may occur very rarely, and only as a result of an accidental gas leak;
- marine vessels and mobile offshore units, unless otherwise stated;
- certain means of transport.

The Directive also applies to second-hand equipment, if reconditioned.

■ Product classification

This European Directive establishes an initial divide between equipment intended for environments with a firedamp (group I) and other environments (group II). Group I therefore includes all equipment intended for use in mines and the associated plants, while group II encompasses a vast range of plant applications, ranging from industrial chemicals to small-scale cake producers.

A further distinction is made for group II products, concerning the classification of equipment intended for areas in which explosive atmospheres may form if gas or dust is present.

In accordance with the ATEX Directive, devices and components are divided into **two groups** depending on their application:

Group I = MINES:

equipment intended for use in underground environments, in mines and their surface plants exposed to the risk of methane leaks (firedamp) and/or combustible dust (from coal). This group is split into **2 categories**, based on the protection level guaranteed by the equipment:

M1 = very high

M2 = high

Group II = SURFACE:

equipment intended for use in other environments (not mines) in which explosive atmospheres are likely to form.

This group is split into **3 categories**, based on the protection level guaranteed by the equipment and the type of atmosphere:

1G/1D = very high

2G/2D = high

3G/3D = normal

94/9/EC certification							
group I		group II					
equipment intended for use in mines and corresponding surface plants		equipment intended for use in environments where the formation of explosive atmospheres is possible					
category							
M1	M2	1G	1D	2G	2D	3G	3D
		gas	dust	gas	dust	gas	dust
		zone					
		0	20	1	21	2	22



CE labelling and CE declaration of conformity

■ Applications: ATEX Zones and Categories

ZONES

The risk presented by areas with an explosive atmosphere can be very different, depending on the length of time it can effectively manifest itself. An environment in which gas or dust is present at hazardous levels for a few hours cannot be considered the same as an area in which the hazardous mixture is always present.

As such, standards in the EN 60079 and EN 61241 series identify three different zones, grouped according to the risk level, and the connection between these and the category of product which can be installed.

Zones in which gas is present: When the hazard is due to the presence of gas, fumes or mist containing flammable substances, European Directive 1999/92/EC provides classification for 3 zones as follows:

- **zone 0** – area in which an explosive atmosphere is often present, permanently or for long periods of time;
- **zone 1** – area in which the formation of an explosive atmosphere is likely to occur occasionally during routine activities;
- **zone 2** – area in which, during routine activities, the formation of an explosive atmosphere is unlikely or, if it does occur, it only persists for a short period of time.

Zones in which dust is present: The classification method for areas subject to the formation of explosive atmospheres due to the presence of dust is the same as the method used for gas. The zones in this case are as follows:

- **zone 20** - area in which an explosive atmosphere is often present, permanently or for long periods of time, such as dust extraction systems, inside silos;
- **zone 21** - area in which the formation of an explosive atmosphere is likely to occur occasionally during routine activities, such as the immediate vicinity of dust loading and unloading areas;
- **zone 22** – area in which, during routine activities, the formation of an explosive atmosphere is unlikely or, if it does occur, it only persists for a short period of time, such as areas near extraction inlet nozzles. The latter zone is usually the largest, as the classification includes all the areas next to filter casing vents or equipment which is rarely opened and areas where bags or packaging elements are stores and handled.

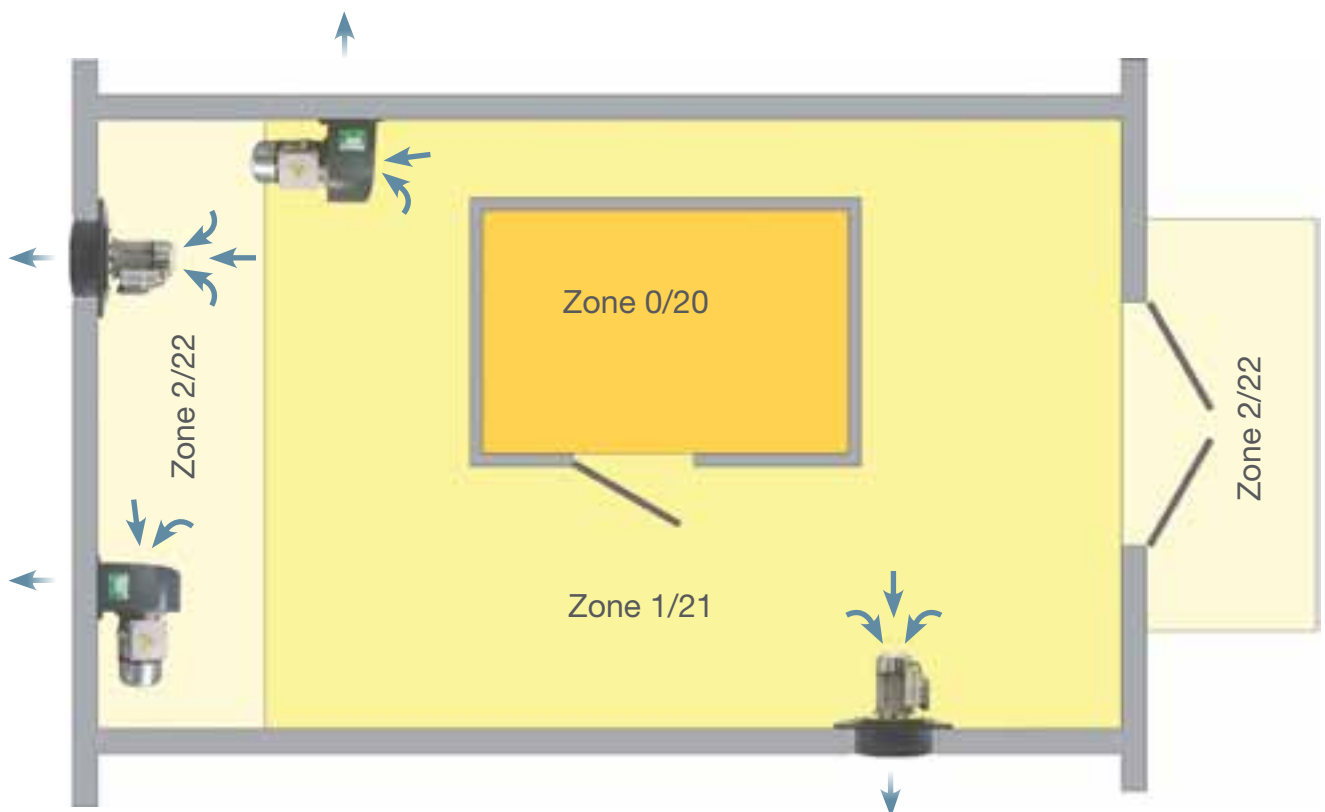

CATEGORIES

Category 1: Equipment falling into his category is intended for use in environments where explosive atmospheres caused by mixtures of air and gas, fumes or mist, or air and dust mixtures are present, permanently, frequently or for long periods of time.

Equipment falling into this category must guarantee the required protection level, even in the event of exceptional faults, and feature protection devices so that:

- if one of the protection devices becomes faulty, at least one other independent device will guarantee the required protection level is maintained;
- or, if two faults occur independently of one another, the required protection level is guaranteed.

Category 2: Equipment falling into his category is intended for use in environments where explosive atmospheres caused by mixtures of air and gas, fumes or mist, or air and dust mixtures are likely to occur. The protection devices falling into this category must guarantee the required protection level, even in the event of recurrent faults or operating defects which should usually be noted.

Category 3: Equipment falling into his category is intended for use in environments where explosive atmospheres caused by mixtures of air and gas, fumes or mist, or air and dust mixtures are unlikely to occur, or where they only occur rarely and for short periods of time. Equipment falling into this category guarantees the required protection level under normal operating conditions.

Zones (classified in accordance with 1999/92/EC) and equipment protection levels (**Categories**) can therefore be combined in accordance with the following table:

Explosive atmosphere presence	Equipment protection level	Usage zone with GAS present	Category	Usage zone with DUST present	Category
Always Present (or present for long periods)	Very high	0	1G	20	1D
Very Likely (during routine activities)	High	1	2G	21	2D
Not Likely (occasional or present only for short periods)	Normal	2	3G	22	3D

NOTE:

Equipment belonging to the higher categories may also be used for lower categories: for example, equipment suitable for zones 20 or 21 may also be used in zone 22.

All zones at risk of explosion MUST be classified in accordance with European Directive 1999/92/EC.

Vortice equipment falls into GROUP II category 2GD (zone 1-21) and it is this group which is examined most widely.

NOTE:

These products are also suitable for zone 2-22.

■ Environments in which gas is present (category G)

If the equipment must be used in areas where gas is present (**category G**), it must be categorised further, by gas group

and on the basis of the maximum surface temperatures, as described in the table below:

GAS GROUP	TEMPERATURE CLASS					
	T1 = 450°C	T2 = 300°C	T3 = 200°C	T4 = 135°C	T5 = 100°C	T6 = 85°C
IIC	Hydrogen	Acetylene				Ethyl Nitrate Carbon Disulfide
IIB	Coke gases Water gases	1,3-Butadiene Ethylbenzene Ethylene Ethylene Oxide	Hydrosulfuric Acid Isoprene Petroleum	Diethyl Ether		
IIA	Ethyl Acetate Methyl Acetate Acetone Acetic Acid Methyl Alcohol Ammonia Benzene Benzol Butanone Chloromethylene Ethane Methane Methanol Carbon Monoxide Naphthalene Propane Toluene Xylene	Butyl Acetate Propyl Acetate Amyl Alcohol Ethyl Alcohol Isobutyl Alcohol n-Butyl Alcohol Acetic Anhydride Cyclohexanone Liquid gas Natural gas Monoamyl Acetate n-Butane	Cyclohexane Cyclohexanol Decane Heptane Hexane Diesel oil Kerosene Naphtha Pentane	Acetaldehyde Ether		
I	Methane					

By Temperature Class (T1-T6) we mean the maximum surface temperature, at any point, reached by the equipment during operation under the specified conditions and in the event of any foreseeable breakdown conditions.

NOTE:

The gas groups and temperature classes were devised so that the highest also include the categories below them:

- equipment belonging to a specific gas group is also suitable for 'lower' gas groups: for example, a motor for group IIB is also suitable for group IIA;
- a motor for group IIC is also suitable for groups IIA and IIB;
- a machine which reaches maximum surface temperatures of 85°C (T6) includes T5-T4-T3...: 85°C is, in fact, the maximum temperature reached by the appliance, and as it is a low value, the risk of triggering an explosion is also very low.

The T6 surface temperature, even lower, is therefore the most restrictive condition.

ATEX products from Vortice have motors suitable for group II and are therefore suitable for groups IIC, IIB and IIA.

■ Environments in which dust is present (category D)

To protect against flammable dust, its ignition temperature must be taken into account, both in cloud form and deposited layer form. The surface temperature of the casing, indicated on the motor rating plate, must be lower

than the ignition temperature used as a reference.

The reference temperature is the lower of the two values; below is a theoretical example of how to calculate the reference temperature when choosing the most suitable product:

How to determine the maximum surface temperature of the motor	Cloud	5mm Dust Layer
Ignition temperature ↓	T_{cl}	T_{5mm}
Safety temperature ↓	$T_{Scl} = 2/3T_{cl}$	$T_{S5mm} = T_{5mm} - 75^{\circ}\text{C}$
Maximum allowable temperature ↓	T_{MAX} = equal to the lower value between T_{Scl} and T_{S5mm}	
Maximum surface temperature of the motor	$\leq T_{MAX}$	

SOURCE:

Article published in 'Ambiente & Sicurezza' (Environment & Safety) magazine from 'Sole 24 Ore' on 20/02/2007: 'Presenza di polveri combustibili o esplodenti base della classificazione dei luoghi pericolosi' (Presence of combustible or exploding dust based on the classification of hazardous areas) by Gianluca Saputi P.I. di III U.F. di ISPESL (National Institute for Occupational Safety and Prevention).

Vortice ATEX products are suitable for applications when the maximum surface temperature is equal to or higher than 135 °C

A few calculation examples are provided below:

Dust	Cloud ignition temperatures (°C) T_{cl}	Cloud safety temperature (°C) T_{Scl}	5mm layer ignition temperatures (°C) T_{5mm}	5mm layer safety temperature (°C) T_{S5mm}
Aluminium	590	442	< 450	375
Coal dust	380	285	225	150
Flour	490	367	390	315
Corn dust	510	382	300	225
Methyl cellulose	420	315	320	245
Soot	810	607	570	495
PVC	700	525	< 450	375
Sugar	490	367	460	385

Protection methods

Non-electrical and electrical equipment in potentially explosive areas is constructed so as to avoid risking an explosion: various **prevention and protection methods** are used to prevent this risk from arising.

The basic **prevention** methods are as follows:

- measures to ensure that the ignition source does not manifest itself (methods c e g);
- measures to ensure that the ignition source does not become effective (method b);
- measures to ensure that the ignition source does not come into contact with the atmosphere (methods fr, k and p).

Prevention method	Labelling
Construction safety	c
Intrinsic safety	g
Ignition source control	b
Restricted breathing	fr
Pressurisation	p
Liquid immersion	k

All ATEX products from Vortice are labelled as ‘b’ for the non-electrical part, meaning that specific construction and size-related instructions must be applied regarding:

- minimum distance values, both through the air and over surfaces;
- the use of insulating materials with a high trace resistance;
- the elimination of corners in which static electricity could accumulate;
- ensuring that both electrical and mechanical parts are coupled correctly and securely;
- minimum distance values between fixed and rotary parts (e.g. between iron, rotor/stator, ventilation, etc.);
- temperature increase limits, considering a jammed rotor situation, and normal operation under the least favourable heat conditions (least favourable power supply voltage).

The basic **protection** methods are as follows:

- keep hazardous parts separated in casing, so as to contain the explosion (method d);
- avoid contact between hot points and the potentially explosive atmosphere by placing solids, liquids or gases in between (methods m, p, q, o, t);
- take measures to limit the generation of hazardous hot points to eliminate the risk of faults and limit the energy to a level which is not high enough to cause ignition (methods e, n, ia, ib, t).

Protection method	Labelling
For prevention	n
Explosion proof casing	d
Pressurisation	p
Encapsulation	m
Oil immersion	o
Sand filled	q
Increased safety	e
Intrinsic safety cat. a	ia
Intrinsic safety cat. b	ib

All ATEX motors from Vortice are labelled as ‘e’, therefore electrical parts must be fitted with suitable devices protecting against inverse time overloads in compliance with ATEX 94/9/EC and according to the following labelling: **II (2) G/D**. These devices prevent sparks, electrical arcs and surface overheating from occurring during service (including non-standard startup and operating conditions while the rotor is jammed), which could cause ignition of the potentially explosive atmosphere surrounding both internal and external parts of the motor.

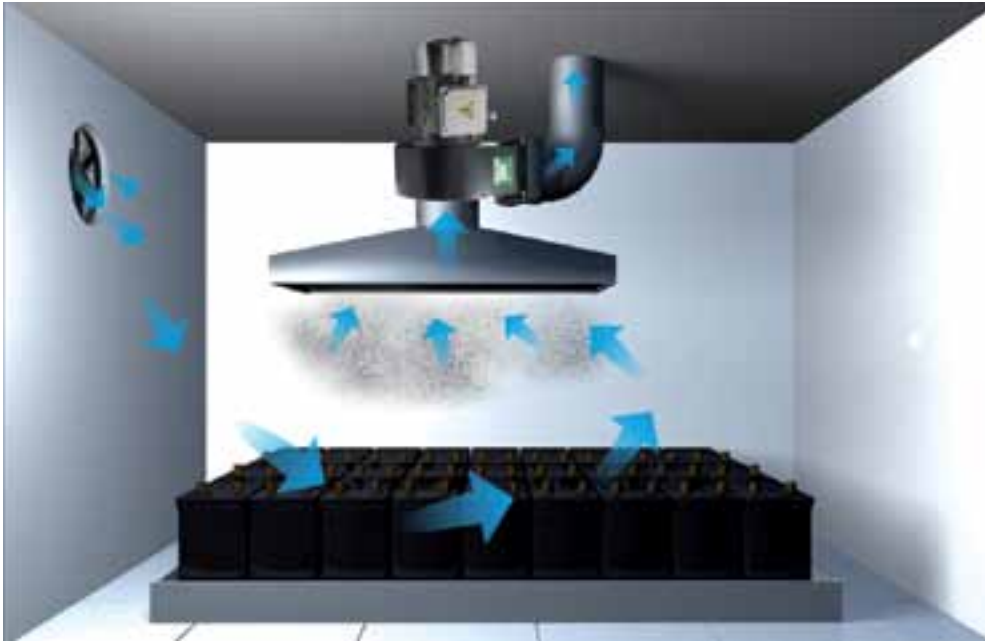

Example of a battery room (classified as zone 1), in which HYDROGEN is released: under these conditions, the use of extractor fans in the immediate vicinity of the batteries is compulsory and a further installation near the ceiling is also recommended.

The classification and identification of these environments must be carried out by the relevant authorities.

■ What does the CE label on ATEX products mean?

The CE label is the final act in which the manufacturer declares that the product it has created and released for sale was made in compliance with all applicable specifications and requirements set out in the ATEX Directive 94/9/EC, and that the product has undergone the relevant conformity assessment procedures.

If a product is subject to several directives, its CE label indicates that it conforms to all applicable directives.

Example of Vortice ATEX C-series labelling

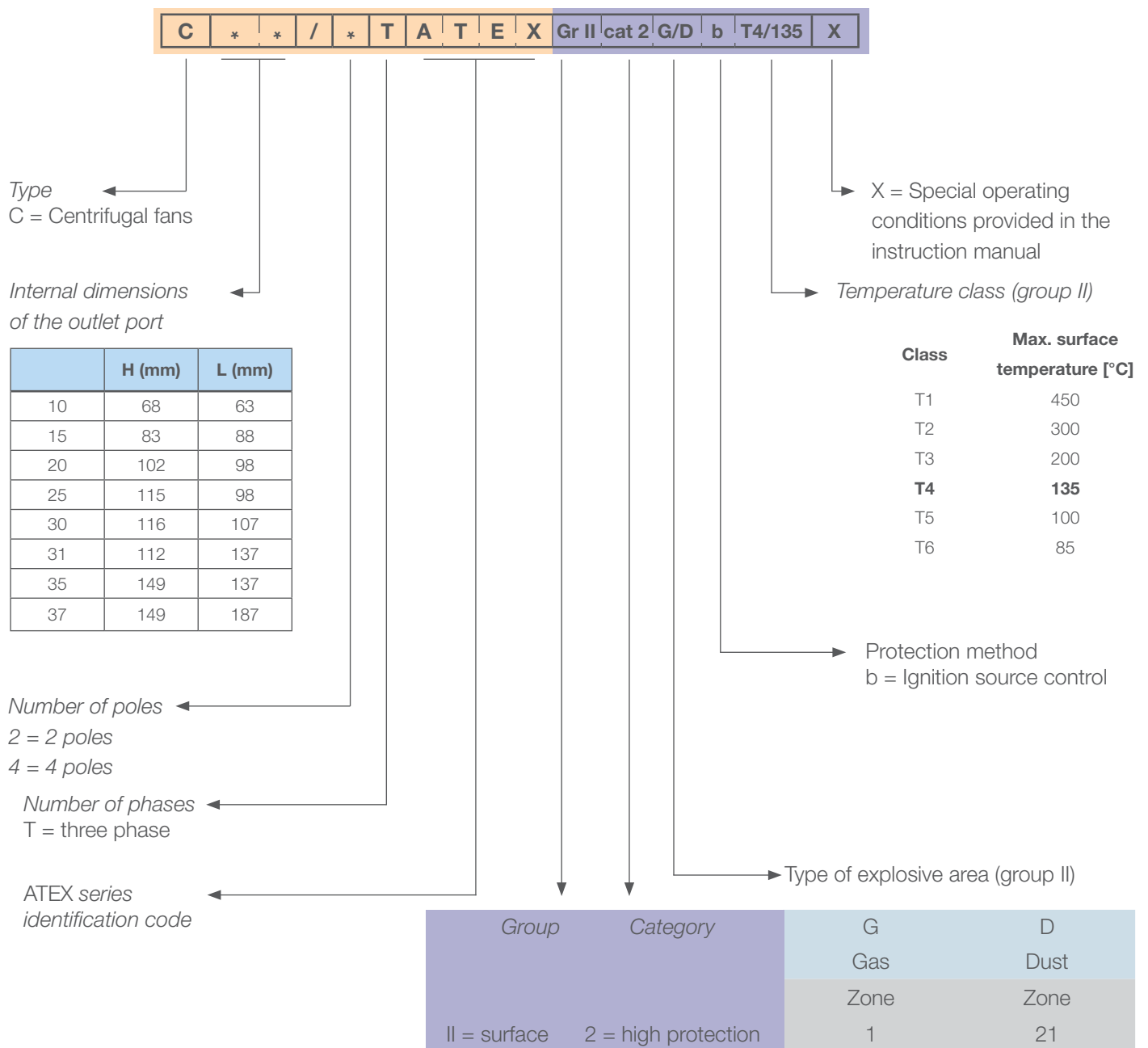

Example of Vortice ATEX E-series labelling



Type
E = Axial fans

Nozzle diameter dimensions

	nominal Ø (mm)
25	250
30	315
35	355
40	400
45	450
50	500
60	630

Number of poles
4 = 4 poles
6 = 6 poles

Number of phases
M = single phase
T = three phase

ATEX series identification code

X = Special operating conditions provided in the instruction manual

Temperature class (group II)

Class	Max. surface temperature [°C]
T1	450
T2	300
T3	200
T4	135
T5	100
T6	85

Protection method
b = Ignition source control

Type of explosive area (group II)

Group	Category	G	D
		Gas	Dust
		Zone 1	Zone 21
II = surface	2 = high protection		

■ Atex range: centrifugal and axial

The range includes centrifugal (three phase) and axial (single and three phase) fans, supplied on request.

Vortice ATEX C-series

Code	PRODUCT NAME
30301	C 10/2 T ATEX Gr II cat 2G/D b T4/135 X
30304	C 15/2 T ATEX Gr II cat 2G/D b T4/135 X
30305	C 20/2 T ATEX Gr II cat 2G/D b T4/135 X
30306	C 25/2 T ATEX Gr II cat 2G/D b T4/135 X
30307	C 30/2 T ATEX Gr II cat 2G/D b T4/135 X
30308	C 30/4 T ATEX Gr II cat 2G/D b T4/135 X
30309	C 31/4 T ATEX Gr II cat 2G/D b T4/135 X
30310	C 35/4 T ATEX Gr II cat 2G/D b T4/135 X
30311	C 37/4 T ATEX Gr II cat 2G/D b T4/135 X

Vortice ATEX E-series

Code	PRODUCT NAME
40301	E 254 M ATEX Gr II cat 2G/D b T4/135 X
40302	E 304 M ATEX Gr II cat 2G/D b T4/135 X
40304	E 354 M ATEX Gr II cat 2G/D b T4/135 X
40306	E 404 M ATEX Gr II cat 2G/D b T4/135 X
40308	E 454 M ATEX Gr II cat 2G/D b T4/135 X
40309	E 254 T ATEX Gr II cat 2G/D b T4/135 X
40310	E 304 T ATEX Gr II cat 2G/D b T4/135 X
40313	E 354 T ATEX Gr II cat 2G/D b T4/135 X
40314	E 404 T ATEX Gr II cat 2G/D b T4/135 X
40315	E 454 T ATEX Gr II cat 2G/D b T4/135 X
40316	E 504 T ATEX Gr II cat 2G/D b T4/135 X
40319	E 506 T ATEX Gr II cat 2G/D b T4/135 X
40317	E 604 T ATEX Gr II cat 2G/D b T4/135 X
40318	E 606 T ATEX Gr II cat 2G/D b T4/135 X



ATEX C-SERIES



GAS



DUST



CENTRIFUGAL FANS FOR INSTALLATION IN POTENTIALLY EXPLOSIVE AREAS

Product specifications:

- 9 three phase models.
- ATEX certified for use in areas at risk of explosion due to gases and/or dust particles.
- Airflow up to 2150 m³/h.
- High pressures over 800 Pa.
- Constant operating temperature between -20°C and +40°C.
- ATEX certified asynchronous induction motors.
- Aluminium centrifugal impeller with front blades and die-cast aluminium hub.
- Double-coated sheet-steel frame with spiral housing.
- Brushed copper nozzles.
- Double-coated galvanised steel wire mesh over the inlet port.
- Metal cable gland for ATEX certified electrical connection.
- Painting consisting of protective base coat and polyurethane finishing paint.
- Protection class: IP65.
- Insulation: Class I
- Constructed in compliance with EN 14986 standards governing the design of fans operating in potentially explosive areas.
- IMQ 10 ATEX 029 X certified.

APPLICATIONS

These appliances are designed for wall or ceiling installation, or can even be ducted.

The classification and identification of these environments must be carried out by the relevant authorities.

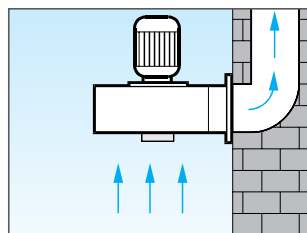
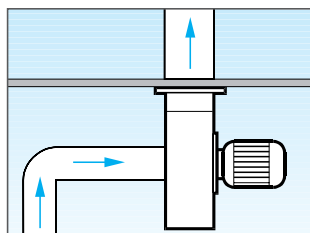
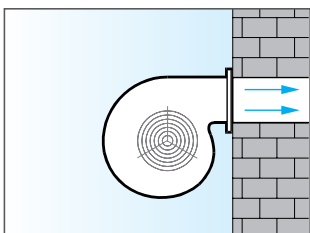

Examples of ventilation (pictures a and b).



Picture a



Picture b

DIMENSIONS

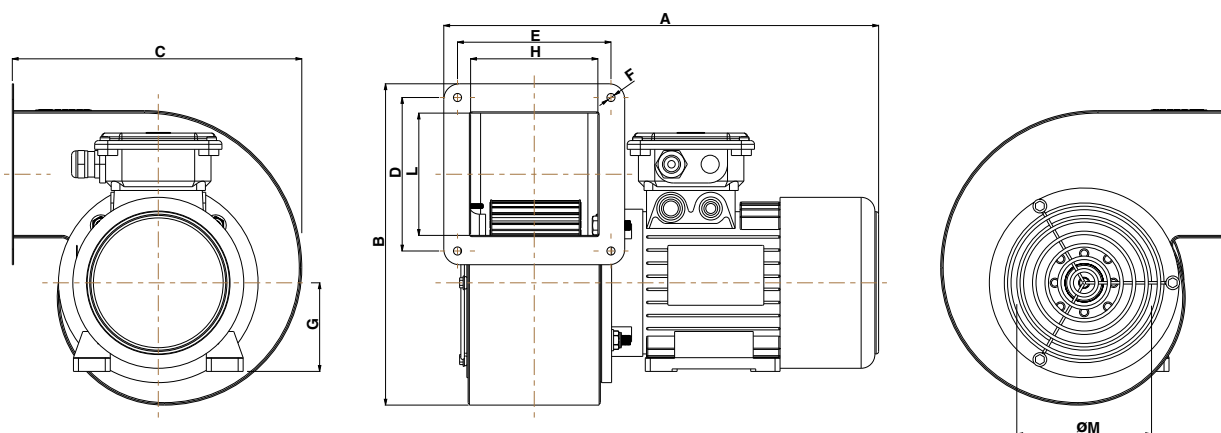

Dimensions (mm)

MODEL	A	B	C	D	E	F	G	H	L	Ø M
C 10/2 T ATEX	260	186	171	72	82	6,5	56	68	63	80
C 15/2 T ATEX	280	234	206	108	100	7	56	83	88	108
C 20/2 T ATEX	350	258	232	123	123	8,50	71	102	98	108
C 25/2 T ATEX	365	258	232	124	142	8,50	71	115	98	108
C 30/2 T ATEX	365	308	272	126	137	8,50	71	117	108	132
C 30/4 T ATEX	365	308	272	126	137	8,50	71	117	108	132
C 31/4 T ATEX	365	400	340	164	139	8,50	71	112	137	170
C 35/4 T ATEX	400	400	340	164	174	8,50	71	149	137	170
C 37/4 T ATEX	425	471	416,50	220	182	8,50	80	149	187	199

TECHNICAL DATA

	MODEL	Code	Voltage V~50 Hz	Max. power absorption (W)	Rated Current (A)	Number of poles	RPM	Max airflow		Max pressure		Sound Pressure Lp dB(A) 3m	kg
								(m ³ /h)	(l/s)	(mmH ₂ O)	(Pa)		
THREE PHASE	C 10/2 T ATEX	30301	400	120	0.36	2	2800	280	77.80	26	255	55.5	4
	C 15/2 T ATEX	30304	400	175	0.39	2	2800	430	119.40	44	430	59	4.5
	C 20/2 T ATEX	30305	400	472	1.09	2	2800	1000	277.80	56	549	66	8.5
	C 25/2 T ATEX	30306	400	482	1.10	2	2800	1100	305.60	67	657	66.5	8.5
	C 30/2 T ATEX	30307	400	902	1.57	2	2800	1350	375.00	83	814	71	10
	C 30/4 T ATEX	30308	400	226	0.95	4	1400	700	194.40	18	177	55	7.5
	C 31/4 T ATEX	30309	400	375	1.01	4	1400	1120	311.10	31	304	61	10.5
	C 35/4 T ATEX	30310	400	401	1.02	4	1400	1500	416.70	34	334	61	11.5
	C37/4 T ATEX	30311	400	803	1.80	4	1400	2150	597.20	48	470	70	17

PRESSURE/PERFORMANCE CURVES

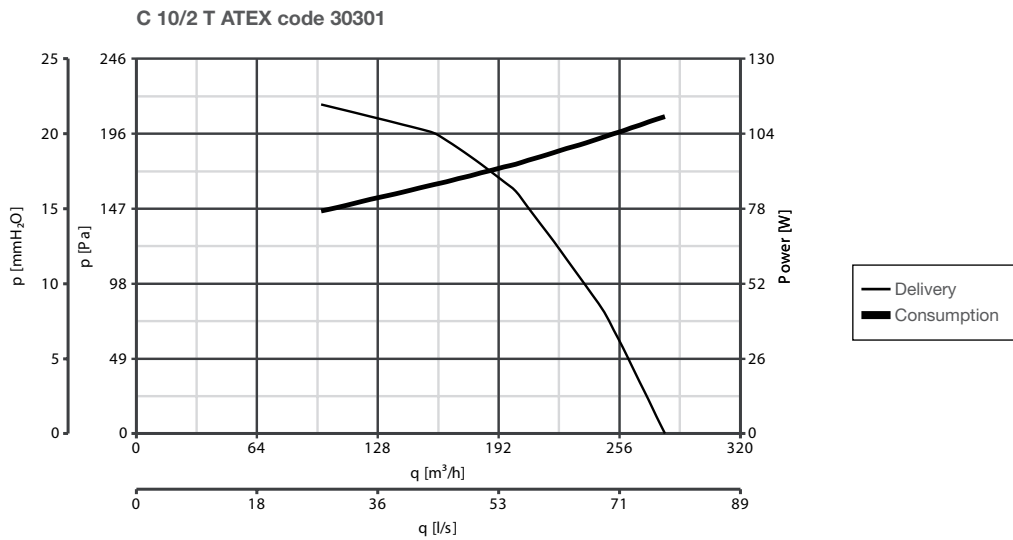

C 15/2 T ATEX code 30304

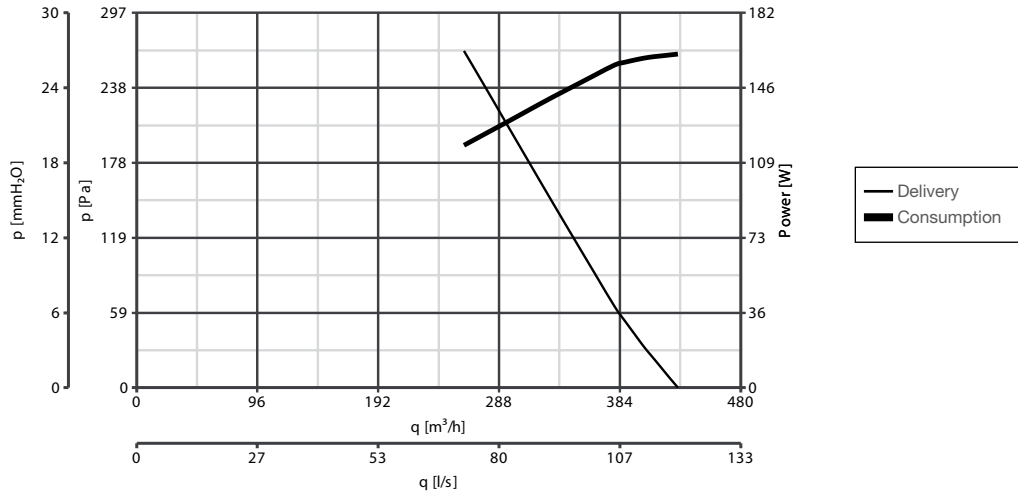

C 20/2 T ATEX code 30305

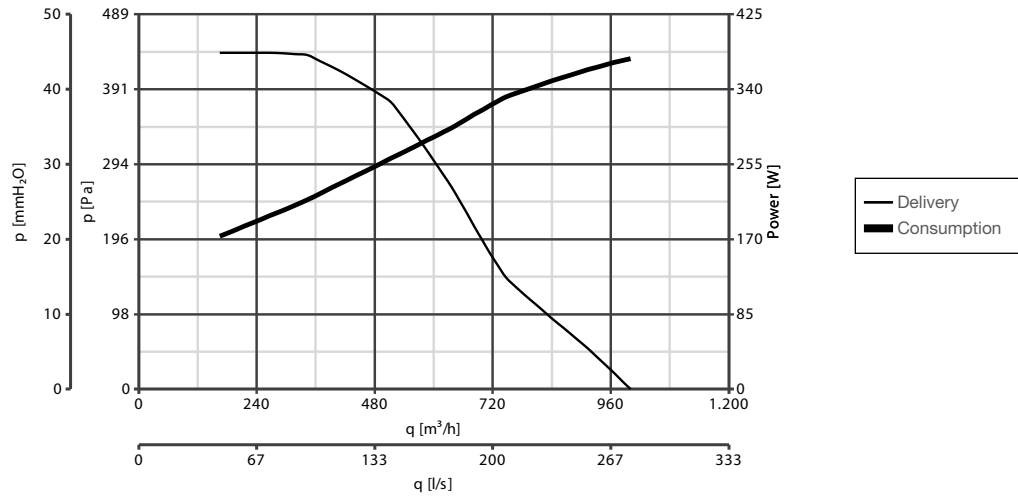

C 25/2 T ATEX code 30306

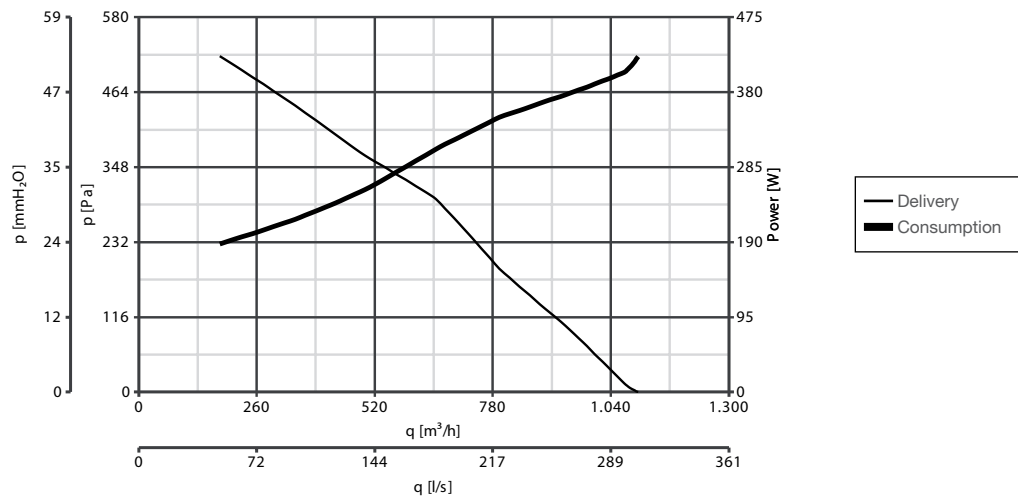

C 30/2 T ATEX code 30307

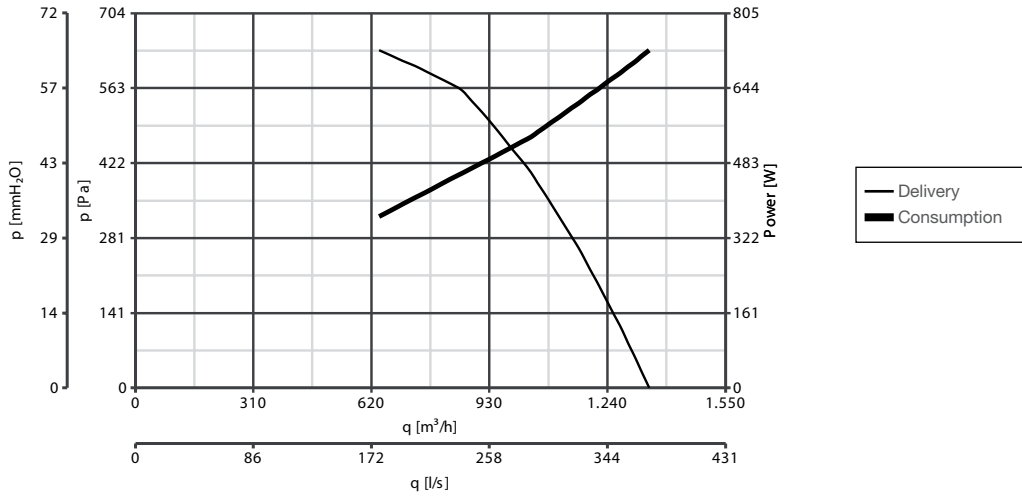

C 30/4 T ATEX code 30308

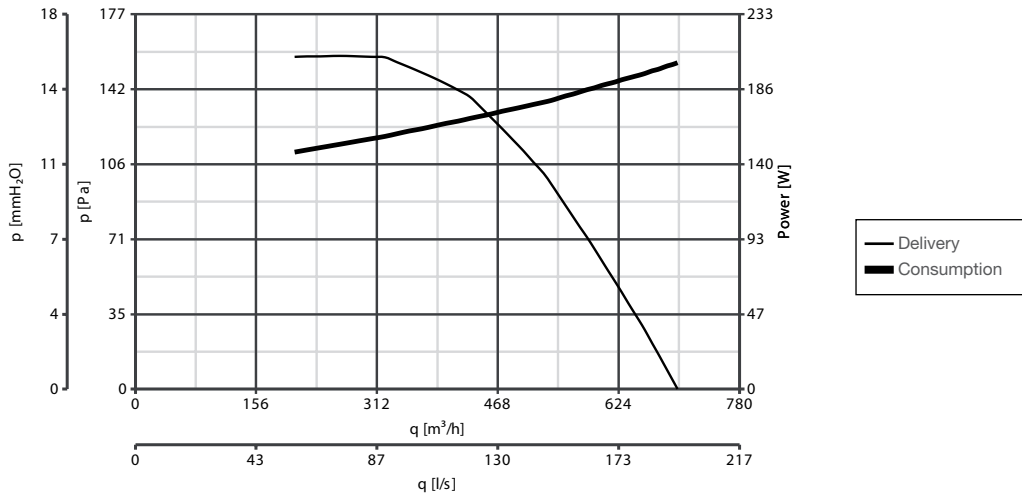

C 31/4 T ATEX code 30309

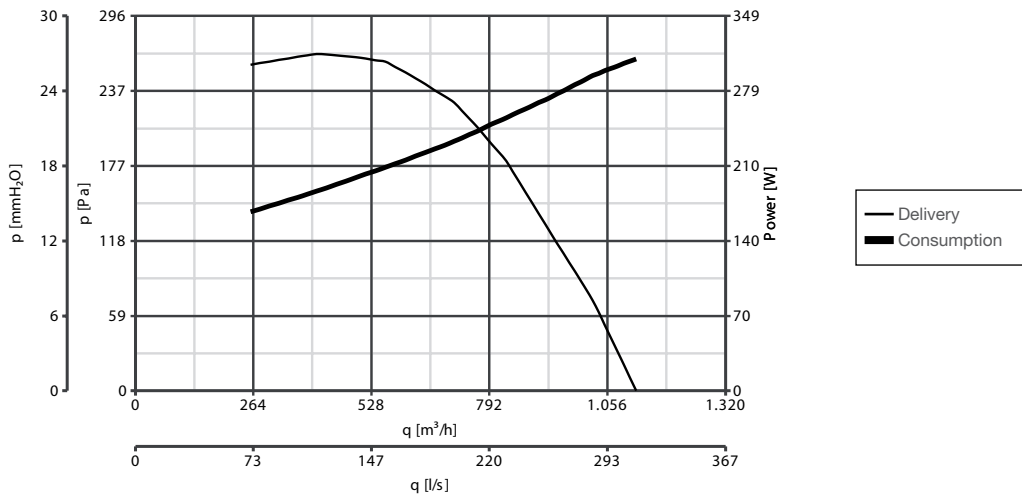

C 35/4 T ATEX code 30310

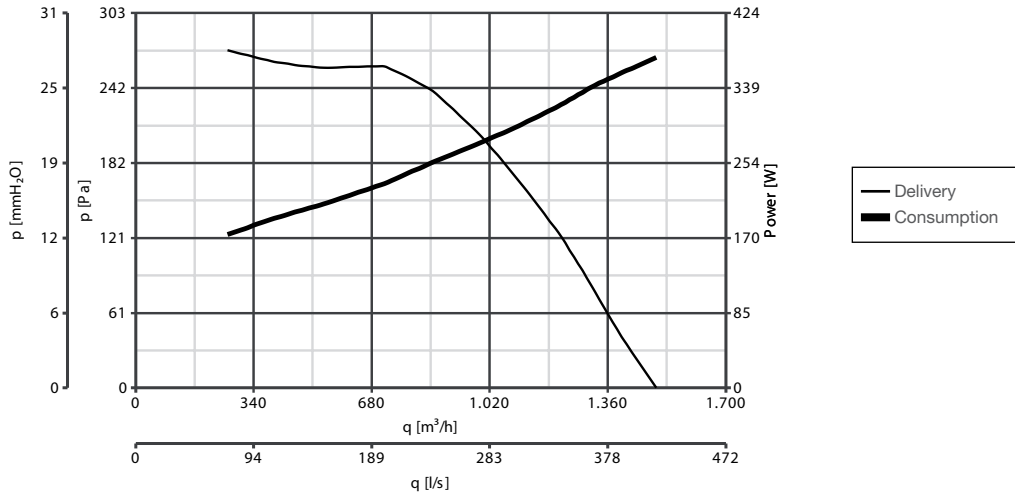

C 37/4 T ATEX code 30311

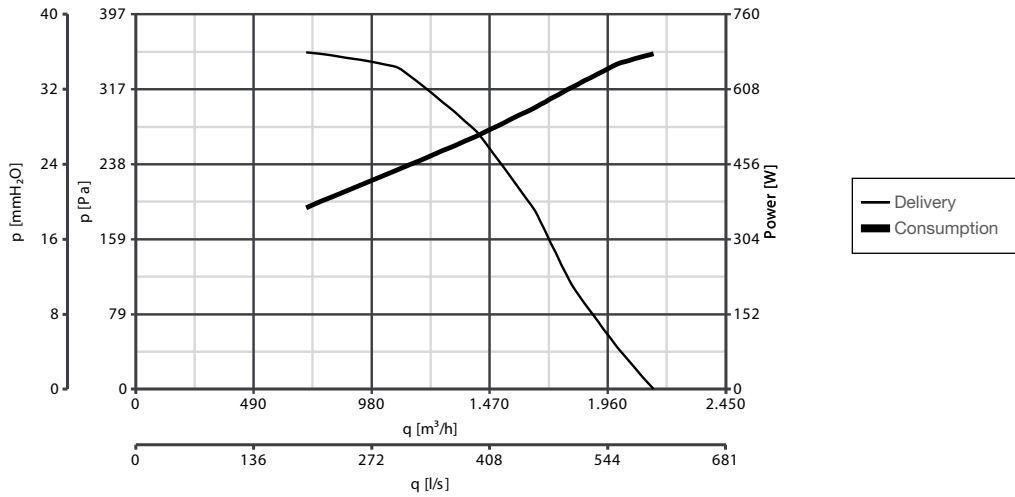

ATEX E-SERIES



GAS



DUST



AXIAL PLATE-MOUNTED FANS FOR INSTALLATION IN POTENTIALLY EXPLOSIVE AREAS

Product specifications:

- 14 models, of which 5 are single phase and 9 three phase.
- ATEX certified for use in areas at risk of explosion due to gases and/or dust particles.
- Airflow up to 6900 m³/h.
- High pressures over 200 Pa.
- Constant operating temperature between -20°C and +40°C.
- ATEX certified asynchronous induction motors.
- Impeller with aluminium hub and plastic blades.
- Frames with double-coated sheet steel mesh and nozzle.
- Double-coated galvanised steel wire mesh over the outlet port.
- In single phase models the condenser is housed in explosion-proof casing.
- Metal cable gland for ATEX certified electrical connection.
- Painting consisting of protective base coat and polyurethane finishing paint.
- Protection class: IP65.
- Insulation: Class I
- Constructed in compliance with EN 14986 standards governing the design of fans operating in potentially explosive areas.
- IMQ 10 ATEX 030 X certified.

APPLICATIONS

These appliances are designed for wall or ceiling installation, or can even be ducted.

The classification and identification of these environments must be carried out by the relevant authorities.

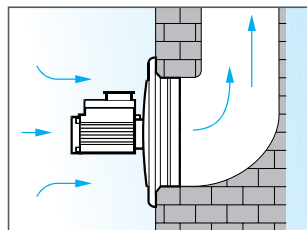
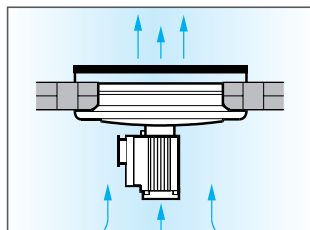
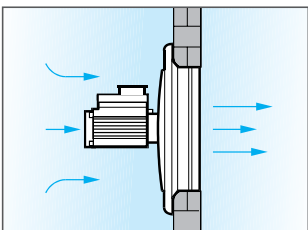

Examples of ventilation (pictures a and b).



Picture a



Picture b

DIMENSIONS

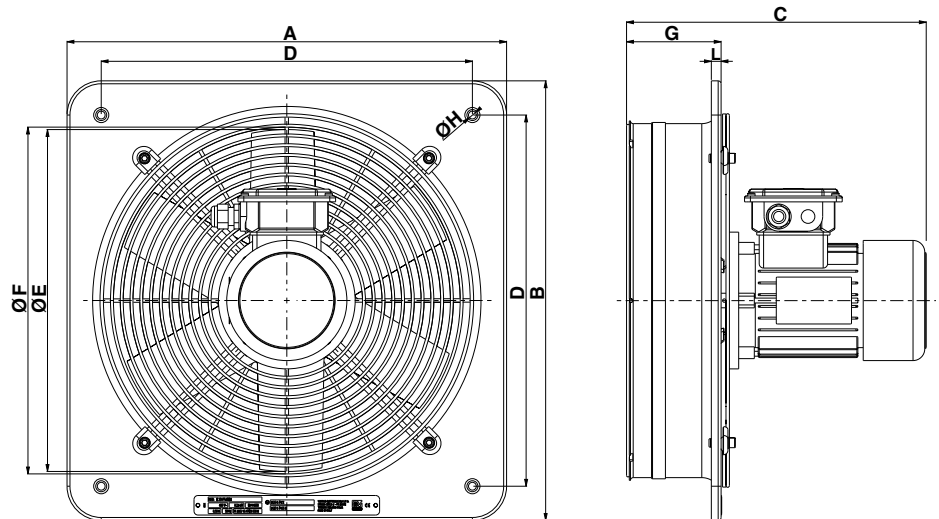

Dimensions (mm)

MODEL	Ø NOM.	A	B	C	D	Ø E	Ø F	G	Ø H	L
E 254 M ATEX	250	320	320	305	280	256	250	95	8	10
E 304 M ATEX	315	380	380	307	330	308	300	97	8	10
E 354 M ATEX	355	450	450	307	380	360	350	97	8	10
E 404 M ATEX	400	510	510	327	430	410	400	117	12	15
E 454 M ATEX	450	630	630	325	530	460	448	112	12	15
E 254 T ATEX	250	320	320	305	280	256	250	95	8	10
E 304 T ATEX	315	380	380	307	330	308	300	97	8	10
E 354 T ATEX	355	450	450	307	380	360	350	97	8	10
E 404 T ATEX	400	510	510	327	430	410	400	117	12	15
E 454 T ATEX	450	630	630	325	530	460	448	112	12	15
E 504 T ATEX	500	630	630	325	530	510	498	112	12	15
E 506 T ATEX	500	630	630	361	530	510	498	112	12	15
E 604 T ATEX	630	760	760	340	630	610	598	127	12	15
E 606 T ATEX	630	760	760	361	630	610	598	127	12	15

TECHNICAL DATA

	MODEL	Code	Voltage V~50 Hz	Max. power absorption (W)	Rated Current (A)	Number of poles	RPM	Max airflow		Max pressure		Sound Pressure Lp dB(A) 3m	kg
								(m ³ /h)	(l/s)	(mmH ₂ O)	(Pa)		
SINGLE PHASE	E 254 M ATEX	40301	230	167	0.75	4	1400	1040	288.90	8.90	87.50	63.2	8
	E 304 M ATEX	40302	230	175	0.77	4	1400	1600	444.40	14	137.30	59.6	8.8
	E 354 M ATEX	40304	230	204	0.97	4	1400	2220	616.70	17.30	169.40	66	9.5
	E 404 M ATEX	40306	230	294	1.27	4	1400	3550	986.10	19.80	193.80	62	11.5
	E 454 M ATEX	40308	230	346	1.50	4	1400	4634	1287.20	19.10	187.60	70	14
THREE PHASE	E 254 T ATEX	40309	400	121	0.49	4	1400	1050	291.70	9.60	94.20	59.6	7
	E 304 T ATEX	40310	400	162	0.53	4	1400	1585	440.30	14.10	138.30	62	8
	E 354 T ATEX	40313	400	208	0.50	4	1400	2550	708.30	18.40	180.50	66	8.8
	E 404 T ATEX	40314	400	268	0.61	4	1400	3480	966.70	17.40	170.30	64.8	10.5
	E 454 T ATEX	40315	400	345	0.70	4	1400	4443	1234.20	18.20	178.30	69.8	13.6
	E 504 T ATEX	40316	400	293	0.64	4	1400	4900	1361.10	17.70	173.80	72.7	13.6
	E 506 T ATEX	40319	400	166	0.47	6	1000	3823	1061.90	10.10	99.20	64	14.5
	E 604 T ATEX	40317	400	374	0.71	4	1400	6900	1916.70	20.80	203.70	75.4	18
	E 606 T ATEX	40318	400	223	0.49	6	1000	5715	1587.50	12.20	119.40	65.5	19.5

PRESSURE/PERFORMANCE CURVES

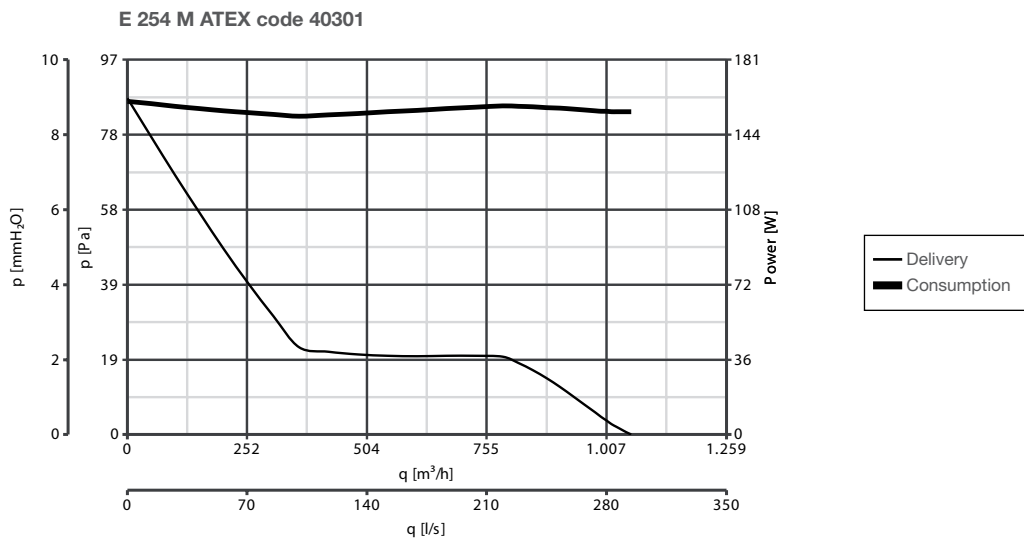

E 254 T ATEX code 40309

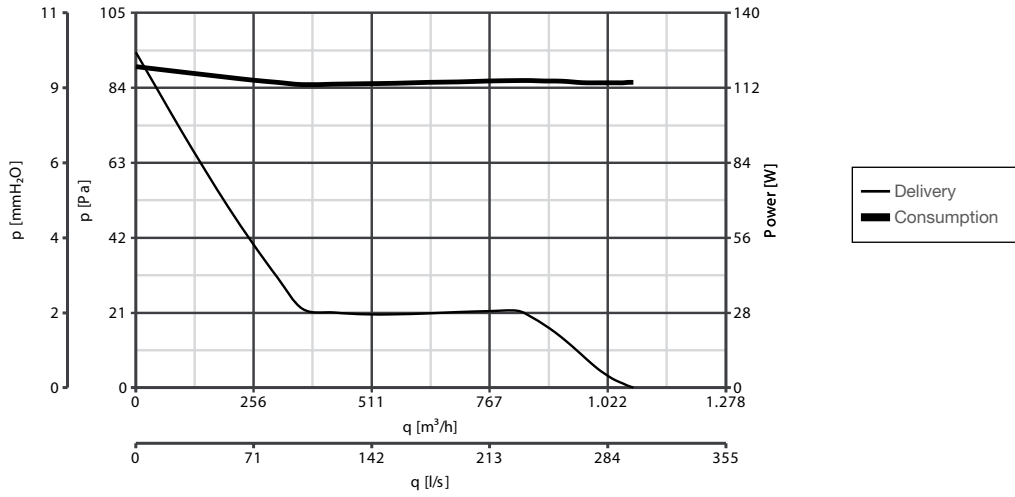

E 304 M ATEX code 40302

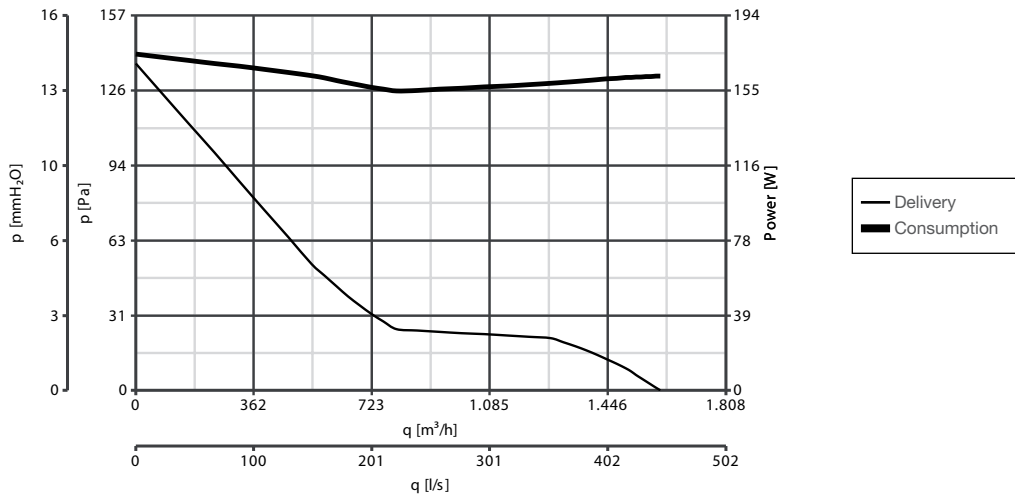

E 304 T ATEX code 40310

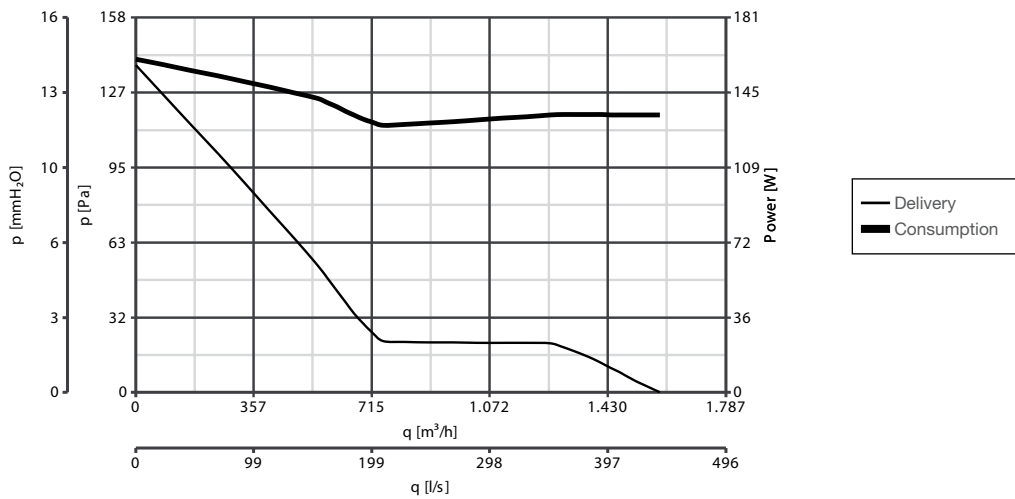

E 354 M ATEX code 40304

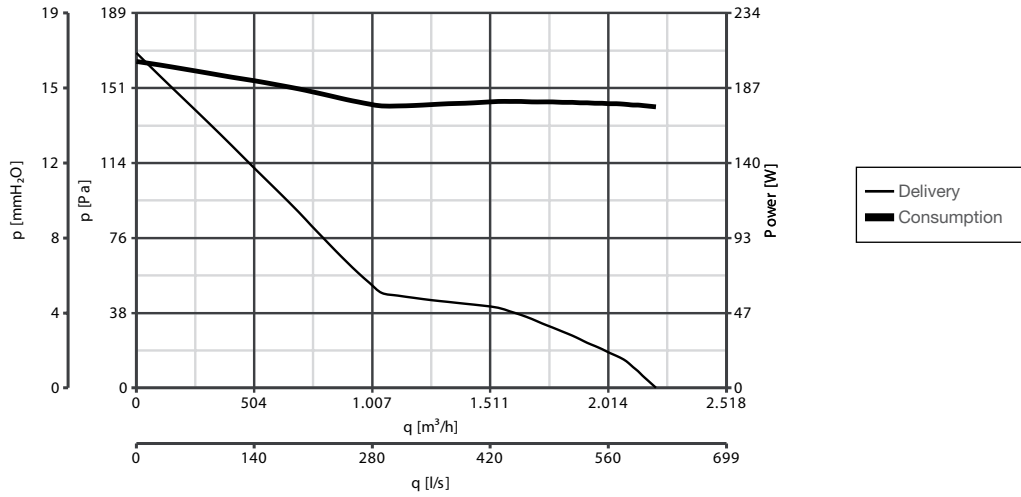

E 354 T ATEX code 40313

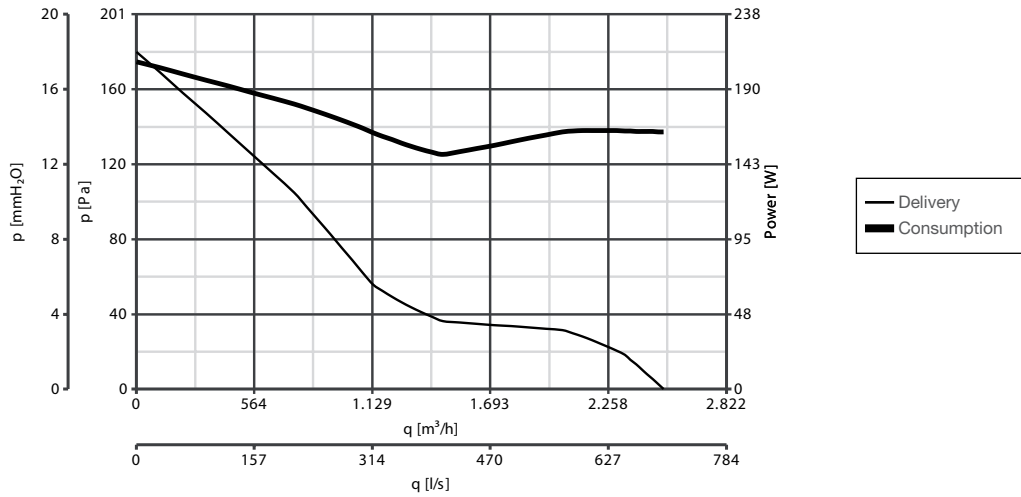

E 404 M ATEX code 40306

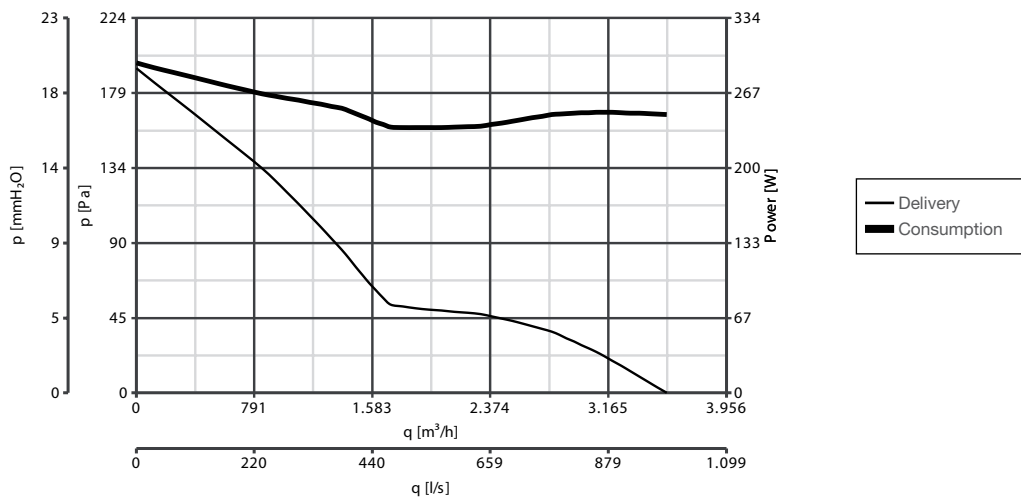

E 404 T ATEX code 40314

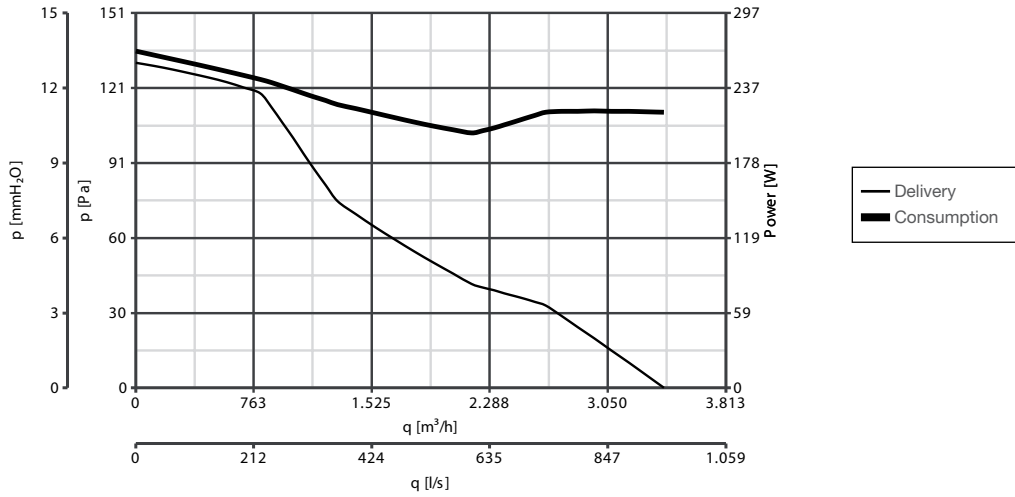

E 454 M ATEX code 40308

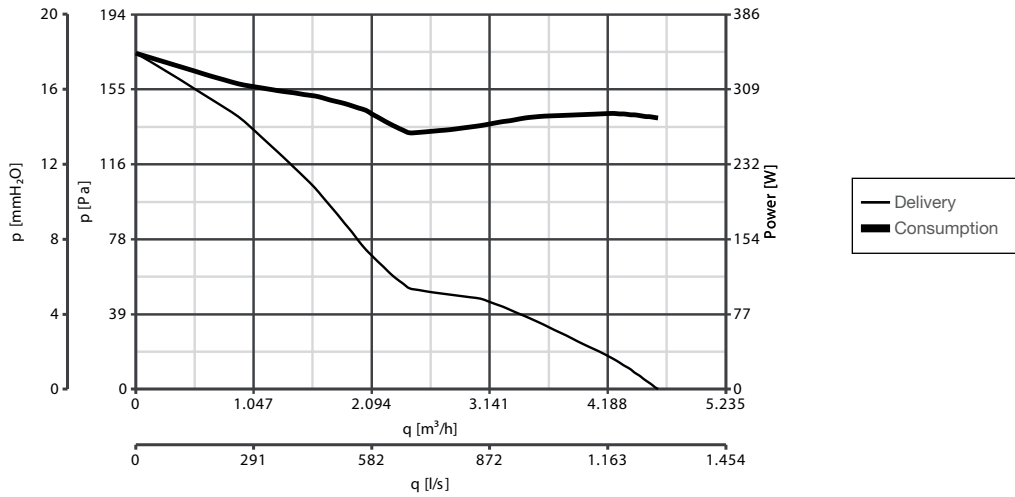

E 454 T ATEX code 40315

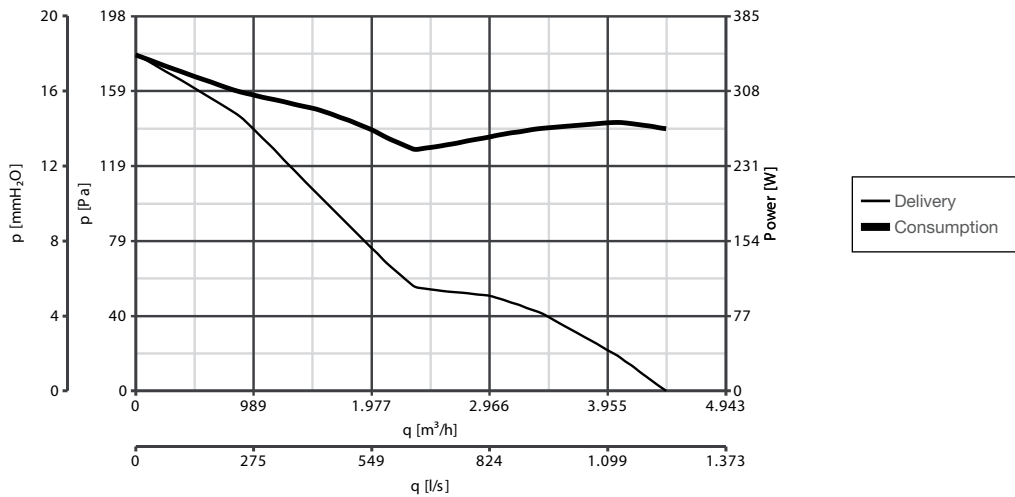

E 504 T ATEX code 40316

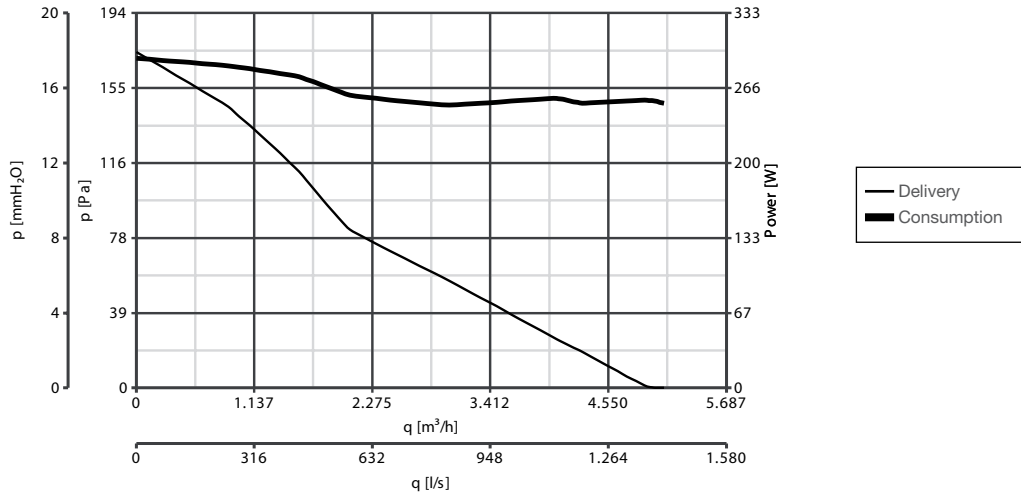

E 506 T ATEX code 40319

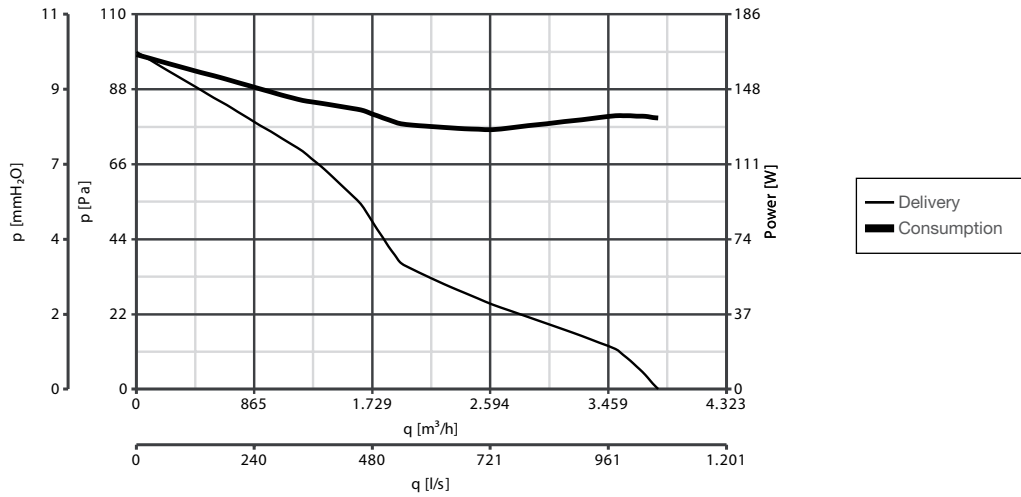

E 604 T ATEX code 40317

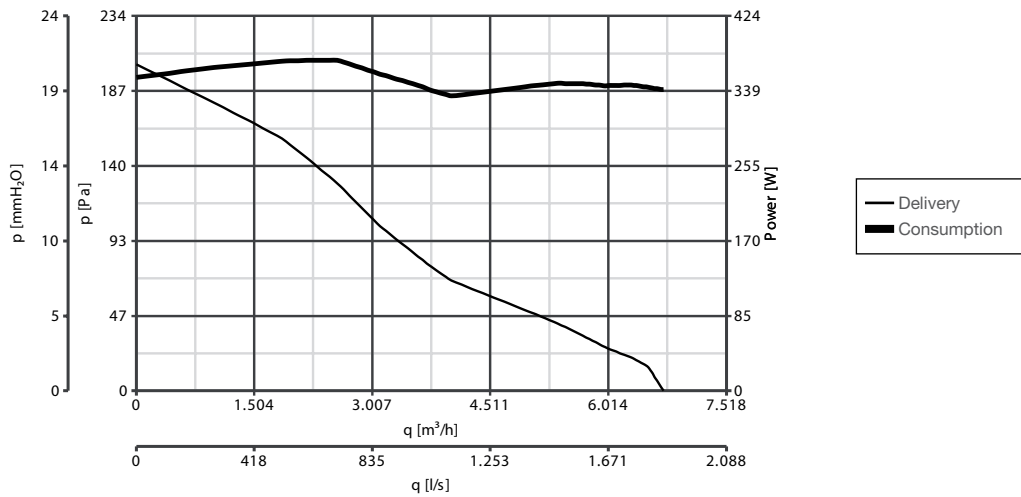

E 606 T ATEX code 40318

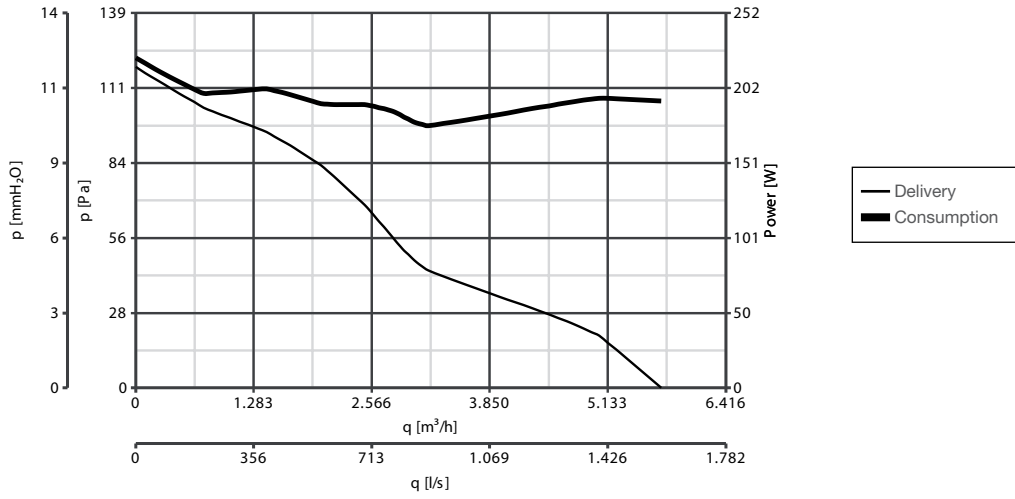

■ Responsibility

The Manufacturer, namely the party responsible for the design and construction of the products referred to in Directive 94/9/EC (with the intention of selling them in the EU under its own brand), also has final and exclusive responsibility in terms of ensuring the product conforms with all applicable regulations.

He is obliged to:

- check whether his product comes under the 94/9/EC Directive, and find out which essential safety requirements apply to it;

- design and construct the product in compliance with the essential health and safety requirements set out by the Directive;
- use finished parts, components and subcontract processing work while maintaining constant supervision at a general level, and possess the necessary skills required to assume responsibility for the product;
- follow procedures for product conformity assessment as stipulated by the Directive (refer to art. 8 and 10).

DIRECTIVE 1999/92/EC PASSED BY THE EUROPEAN PARLIAMENT AND COUNCIL

dated 16th December 1999 and relating to the minimum requirements for improving the safety and health protection of workers potentially at risk from explosive environments

(fifteenth specific directive in accordance with art. 16, paragraph 1 of Directive 89/391/EEC)

EXTRACT:

Art. 4

Assessment of explosion hazards

1. In carrying out the obligations set out by art. 6 paragraph 9 and art. 9 paragraph 1 of Directive 89/391/EEC, the employer must assess the specific risks presented by explosive environments, at the very least taking account of the following elements:

- the likelihood of an explosive environment developing and its duration,
- the likelihood of ignition sources developing and being activated, and how effective they are, including electrostatic discharge,
- the system features, substances used, processes implemented and potential interactions between them,
- the extent of all foreseeable effects.

The explosion risks are assessed globally.

2. Explosion risk assessment must take account of the places which have - or could have - openings connecting them to the areas in which explosive atmospheres may form.

Art. 5

General obligations

In order to safeguard the health and safety of workers, and in accordance with the fundamental principles of risk assessment and the considerations listed in art. 3, the employer must take the necessary precautions to ensure that:

- in areas where explosive atmospheres may form at levels which could put the health and safety of workers or other individuals at risk, working environments are structured so as to ensure that work can be carried out safely;
- in working environments where explosive atmospheres may form at levels which could put the health and safety of workers at risk, suitable checks are carried out while the workers are present, on the basis of the risk assessment results and using suitable technical equipment.

in potentially explosive areas

Art. 8

Document on protection against explosions

In carrying out the obligations set out by art.4, the employer must draw up a document called the 'document on protection against explosions' or similar, keeping it up-to-date.

In particular, this document states:

- that the explosion risks have been identified and assessed,
- that suitable measures will be taken to achieve the objectives set out in this Directive,
- the areas which have been divided into zones according to appendix I,
- the areas in which minimum specifications (appendix II) are applied,
- that the workplaces and equipment, including alarm devices, are designed, used and serviced properly, taking account of all safety considerations,
- that, in line with Council Directive 89/655/EEC (1), measures have been taken to ensure the safe operation of equipment in the workplace.

The document relating to protection against explosions must be completed before work begins, and must be reviewed whenever the workplaces, equipment or procedures are updated, expanded or transformed in any relevant manner. The employer can combine any existing explosion risk assessments, documents or other equivalent reports, compiled as a result of other EC legislation.



Area in which an explosive atmosphere may form

Features:

- triangular shape,
- black lettering on a yellow background, black border (the yellow colour must occupy at least 50% of the sign surface).

Member States may add further explanatory elements as desired.

The Employer is obliged to carry out/commission an explosion risk assessment for the areas involved and those connected, via openings, to the areas in which explosive mixtures may form.

In this assessment, the following must be taken into consideration:

- the likelihood and duration of potentially explosive environment development;
- the likelihood it will become active;
- the system features, substances used, processing techniques implemented and interactions between them;
- the extent of all likely effects.

■ Environments at risk, ATEX Group II

The ATEX Directives are applied in many sectors of industrial manufacturing; the hazardous zones and the materials which create risk potential have been identified for every type of company.

SECTOR	TYPE OF COMPANY	HAZARDOUS ZONES	MATERIALS
Food/agriculture and supply chain for food/agricultural systems and machinery. Food and supply chain for food systems and machinery.	Mills Biscuit factories Cake/pastry factories Semolina factories Sugar factories Machinery for processing foodstuffs Systems for processing foodstuffs Coffee roasting Milling/grinding of cereals and cocoa Bakeries, Distilleries	The typical processing techniques used in the food industry involve moving materials stored in silos, which leads to dust being released into the atmosphere and creating potentially explosive ATEX zones. Explosive dust may form during the transportation and storage of cereals. The drying, grinding and refining of agricultural material/foodstuffs creates an explosion risk. Alcohol-based substances are often used in the food industry, to sterilise controlled environments.	Cocoa, coffee, cereals (dust mixture), wheat flour, soy flour, gelatin, corn, powdered milk, lactose, rye, whey, sugar, granulated sugar
Doors and windows	Metal fixings Metal accessories for fixings Detailed roll forming Superficial processing of metals	Atmosphere potentially explosive due to the presence of metallic dust caused by the processing techniques used in the manufacturing cycle. Over time, layers of micro-dust deposited on the walls, and accumulation in cracks as well as inside automatic machinery. Dust from smoothing procedures. In the manufacturing of moulded metal parts, explosive metallic dust may form during superficial treatment (grinding). This is especially true in the case of light metals and alloys. This metallic dust may cause an explosion risk in separators and filters. Conductive dust is the most dangerous kind.	Aluminium, alloys, titanium, magnesium



SECTOR	TYPE OF COMPANY	HAZARDOUS ZONES	MATERIALS
Pharmaceuticals/hospitals	Medicine production Production of equipment for the pharmaceutical, chemical, cosmetics and food industries	Inertisation and disposal of waste produced during the production cycle. Maximum safety procedures for active ingredients and substances for which the properties are still unknown (R&D). In the production of pharmaceuticals, alcohol-based substances are often used as solvents, and ethanol or its derivatives used to sterilise aseptic chambers. Active and adjuvant substances such as lactose may also be used, and these may cause a dust explosion. Total ISO4 HEPA/ULPA filtration required.	Active ingredients, various chemical components, pharmaceutical products, biohazards
Aeronautical/aerospace Naval, Automotive, Railway	Construction of aeroplanes, trains and motor vehicles Maintenance Precision mechanics Electronics sector for the aerospace industry Painting cabins Processing of resins	Presence of micro-dust in the processing of hi-tech components. Processing of aircraft fuselages. Dust produced by vibration tests on electronic components. Treatment of propellents in the aerospace sector. Extracting kerosene from the tank. Aircraft servicing procedures. Residues of explosive materials inside engines. Construction of wooden/resin boats and presence of explosive fumes. Procedures in machinery rooms and recycling of hydrocarbons.	

SECTOR	TYPE OF COMPANY	HAZARDOUS ZONES	MATERIALS
Fuels, petrol	Refineries Petrol stations Treatment plants for gases, such as diesel and methane Metallurgy Production of electricity	Accidental leaks and non-routine outpouring procedures. The hydrocarbons treated at refineries are all flammable and, depending on their combustion point, may generate an explosive atmosphere, even at room temperature. The environment in which the petroleum treatment equipment is located is usually considered an area at risk of explosion. There are no unclassified areas in these companies. Carbon coke is used in metallurgy and electricity production; it is a highly flammable organic material.	Hydrocarbons, natural gas, LPG, refinery gases, methane, fuels, metallic dust, acids, fossil carbon, pellets
Research, universities and laboratories	Oxygen canisters Glove boxes Test stations	Area adapted for the storage of oxygen or flammable gas canisters. Glove boxes for the processing of explosive or toxic materials. Presence of micro-dust in the processing of hi-tech components. Use of solvents in laboratory tests. Chambers are sterilised using ethanol or flammable solvents.	Various solvents, ethanol, alcohol, gas canisters, oxygen, laboratory products, glove boxes, electronic micro-dust, resins, gallium arsenide, production of photoelectric cells, dust from electric circuits, arsine
Cement and brick factories	Cement, Bricks	Explosive atmospheres may arise in the production of components for the construction industry, with fine granularity in the cement and clinker mill area.	Graphite, cement dust, fine brick dust, fibres
Chemical	Paints, Colours, Soda, Alcohol	Presence of solvents and fumes during the production cycle. Production of Hydrogen in chemical reactions. Transformation of solids, liquids and gases with a resulting risk of explosive atmosphere creation. Use of explosive powders or liquids for product synthesis. Overspills.	Various solvents: acetate, acetylene, acetone, alcohol, ethylene, etc. Soda, processing products

SECTOR	TYPE OF COMPANY	HAZARDOUS ZONES	MATERIALS
Plastic and Rubber	PVC recovery	Explosive dust may form during the transportation and storage of plastic or rubber pellets. In the grinders, in accumulation systems and in dust separation. If this dust is extracted, ATEX equipment from a suitable category must be used.	PVC, plastic micro-dust
Disposal of toxic and explosive waste	Dumping National shooting ranges Production and storage of flares, smoke bombs.	During treatment of waste water at purification plants, the biogases produced may form explosive gas/air mixtures. Disposal of dust, dynamite, detonators, fireworks and security munitions.	Explosive dust, nuclear-contaminated waste, toxic substances
Furniture factories, carpentry workshops, leather treatment, tanneries Textiles	Production of kitchens Production of wooden furniture Processing of timber, plywood, chipboard panels Production of fixings and doors Shoe factories Leather goods producers Textile plants	During wood processing, wood dust is produced and can form explosive dust/air mixtures. Over time, layers of micro-dust deposited on the walls, and accumulation in cracks as well as inside automatic machinery chambers. Dust from smoothing procedures can present an explosion risk as well as an inhalation hazard.	Wood flour, wood (50% pear, 50% walnut), wood (beech), wood (pear), wood sawdust, cork, cellulose (93% soft wood, 6% hard wood). Fine leather dust, fibres
Paper factory	Production of paper	During wood processing, wood dust is produced and can form explosive dust/air mixtures. Over time, layers of micro-dust deposited on the walls, and accumulation in cracks as well as inside automatic machinery chambers. Dust from smoothing procedures can present an explosion risk as well as an inhalation hazard.	Paper micro-dust, cellulose

Code 5.170.084.756

11/14

Vortice Elettrosociali S.p.A
Strada Cerca, 2
Frazione di Zoate
20067 Tribiano (Milano)
Tel. (+39) 02 906991
Fax (+39) 02 90699314
Italia
www.vortice-export.com
export@vortice-italy.com

Vortice France
72, Rue Baratte-Cholet
94106 Saint Maur
CEDEX
Tél. (+33) 1.55.12.50.00
Fax (+33) 1.55.12.50.01
France
www.vortice-france.com
contact@vortice-france.com

Vortice Limited
Beeches House-Eastern Avenue
Burton on Trent
DE13 0BB
Tel. (+44) 1283-49.29.49
Fax (+44) 1283-54.41.21
United Kingdom
www.vortice.ltd.uk
sales@vortice.ltd.uk

